

VENTE - ACHAT - LOCATION - ECHANGE

ELECTRICITE ET MECANIQUE INDUSTRIELLES
MOTEURS TRIPHASES ET CONTINUS
TRANSFORMATEURS H.T.ET B.T.
GROUPES ELECTROGENES

SALE - PURCHASE - RENTAL - EXCHANGE

INDUSTRIAL ELECTRICTY AND MECHANIC
AC AND DC MOTORS
TRANSFORMER HT AND LT
GENERATOR

AANKOOP - VERKOOP - VERHUUR - RUILEN

ELECTICITEIT EN INDUSTRIELE MECANICA
DRIEFASIGE EN GELIJKSTROOMMOTOREN
TRANSFORMATOREN H.S. EN L.S.
STROOMAGGREGATEN

info@focquet.be

Tel : +32.2.255.82.10 / Fax : +32.2.253.05.93

www.focquet.be

///////// ///////// /////////	MOTEUR A CAGE TRIPHASE NEUF 2EC™ – European Electric Company / NIEUW KORTSLUITANKER MOTOR 2€C – European Electric Company / NEW SQUIRREL CAGE MOTOR 2€C –European Electric Company /
Type	100 L
Puissance / Vermogen / Power	4 kW
Tension / Spanning / Voltage	400/690v
Vitesse / Snelheid/ Speed	2880 RPM
Forme de construction / Bouwworm / Construction Form	B3 / B35 / B5
IP	55
Rendement/ Efficiency	84.4
Cos Phi	0.88
Poids / Gewicht/ Weight	33 kg
Autres / Anderen/ Others	Fonte / Gietijzer/ Cast Iron Class (e) : F Echauffement / Opwarming / Heating : B T-Box : orientable - au dessus / orienteerbaar - bovenop / swiveling- top

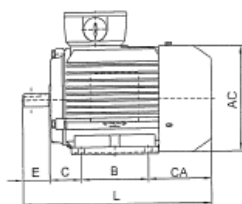

63-132

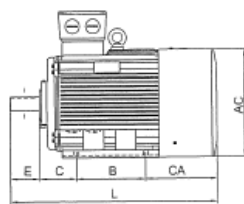

160-200

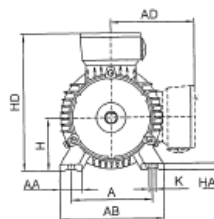
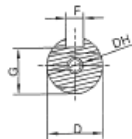

63-132

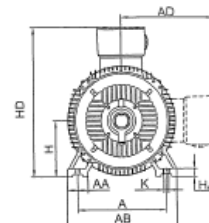

160-200

B3

Mounting Dimensions

Frame	Pôles	A	AA	B	C	D	E	F	G	H	K	AB	AC	AD	HD	L	BB	CA	EA	DA	HA	DH
63		100	30	80	40	11	23	4	8.5	63	7	135	120	70	180	225	100	81	23	11	8	M4X12
71		112	32	90	45	14	30	5	11	71	7	150	136	80	195	250	120	85	30	14	8	M5X12
80		125	34	100	50	19	40	6	15.5	80	10	165	156	145	214	295	130	101	40	19	10	M6X16
90S		140	36	100	56	24	50	8	20	90	10	180	176	155	250	315	130	110	50	24	12	M8X19
90L		140	36	125	56	24	50	8	20	90	10	180	176	155	250	340	155	110	50	24	12	M8X19
100L		160	40	140	63	28	60	8	24	100	12	205	196	180	270	385	176	125	60	28	14	M10X22
112M		190	45	140	70	28	60	8	24	112	12	230	220	190	300	400	180	132	60	28	15	M10X22
132S		216	55	140	89	38	80	10	33	132	12	270	259	210	345	470	230	169	80	38	18	M12X28
132M		216	55	178	89	38	80	10	33	132	12	270	259	210	345	510	238	169	80	38	18	M12X28
160M		254	65	210	108	42	110	12	37	160	15	320	315	255	420	615	260	190	110	42	20	M16X36
160L		254	65	254	108	42	110	12	37	160	15	320	315	255	420	670	304	224	110	42	22	M16X36
180M		279	70	241	121	48	110	14	42.5	180	15	355	355	280	455	700	311	220	110	48	25	M16X36
180L		279	70	279	121	48	110	14	42.5	180	15	355	355	280	455	740	349	220	110	48	28	M16X36
200L		318	70	305	133	55	110	16	49	200	19	395	397	305	505	770	369	241	110	55	30	M20X42

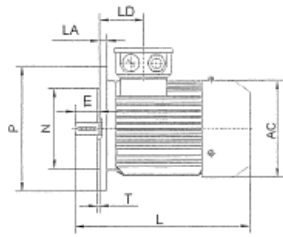

63-132

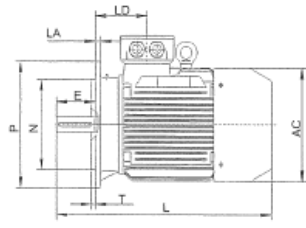

160-200

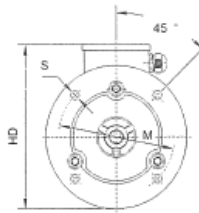
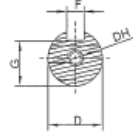

63-132

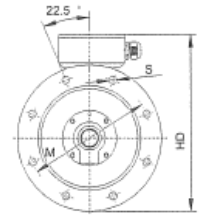

160-200

B5 -B35

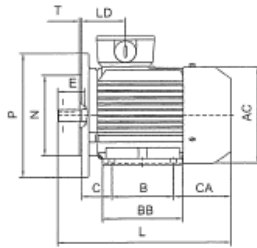

63-132

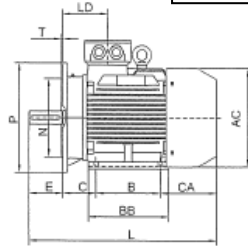

160-200

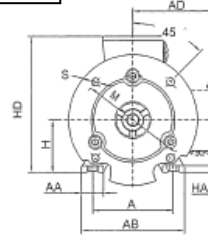
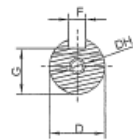

63-132

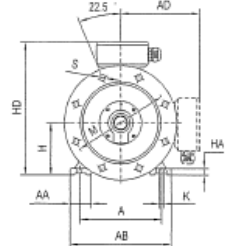

160-200

Frame	Mounting Dimensions						
	LA	M	N	P	S	LD	T
63	10	115	95	140	10	57	3
71	10	130	110	160	10	68	3.5
80	12	165	130	200	12	71.5	3.5
90S	12	165	130	200	12	79.5	3.5
90L	12	165	130	200	12	79.5	3.5
100L	13	215	180	250	15	78.5	4
112M	14	215	180	250	15	86.5	4
132S	14	265	230	300	15	92	4
132M	14	265	230	300	15	92	4
160M	15	300	250	350	19	146	5
160L	15	300	250	350	19	146	5
180M	15	300	250	350	19	158	5
180L	15	300	250	350	19	158	5
200L	17	350	300	400	19	186	5

B14 – B34 petite/small/klein

Frame	A	A2	B	C	D	E	F	G	H	K	M	N	P	S	T	AB	AC	HD	DH	L
63	100	50	80	40	11	23	4	8.5	63	7	75	60	90	M5	2.5	135	120	180	M4X12	225
71	112	56	90	45	14	30	5	11	71	7	85	70	105	M6	2.5	150	136	195	M5X12	250
80	125	62.5	100	50	19	40	6	15.5	80	10	100	80	120	M6	3	165	156	214	M6X16	295
90S	140	70	100	56	24	50	8	20	90	10	115	95	140	M8	3	180	176	250	M8X19	315
90L	140	70	125	56	24	50	8	20	90	10	115	95	140	M8	3	180	176	250	M8X19	340
100L	160	80	140	63	28	60	8	24	100	10	130	110	160	M8	3.5	205	196	270	M10X22	385
112M	190	95	140	70	28	60	8	24	112	12	130	110	160	M8	3.5	230	220	300	M10X22	400
132S	216	108	140	89	38	80	10	33	132	12	165	130	200	M10	3.5	270	259	345	M12X28	470
132M	216	108	178	89	38	80	10	33	132	12	165	130	200	M10	3.5	270	259	345	M12X28	510
160M	254	127	210	108	42	110	12	37	160	15	215	180	250	M12	4	320	315	420	M16X36	615
160L	254	127	254	108	42	110	12	37	160	15	215	180	250	M12	4	320	315	420	M16X36	670

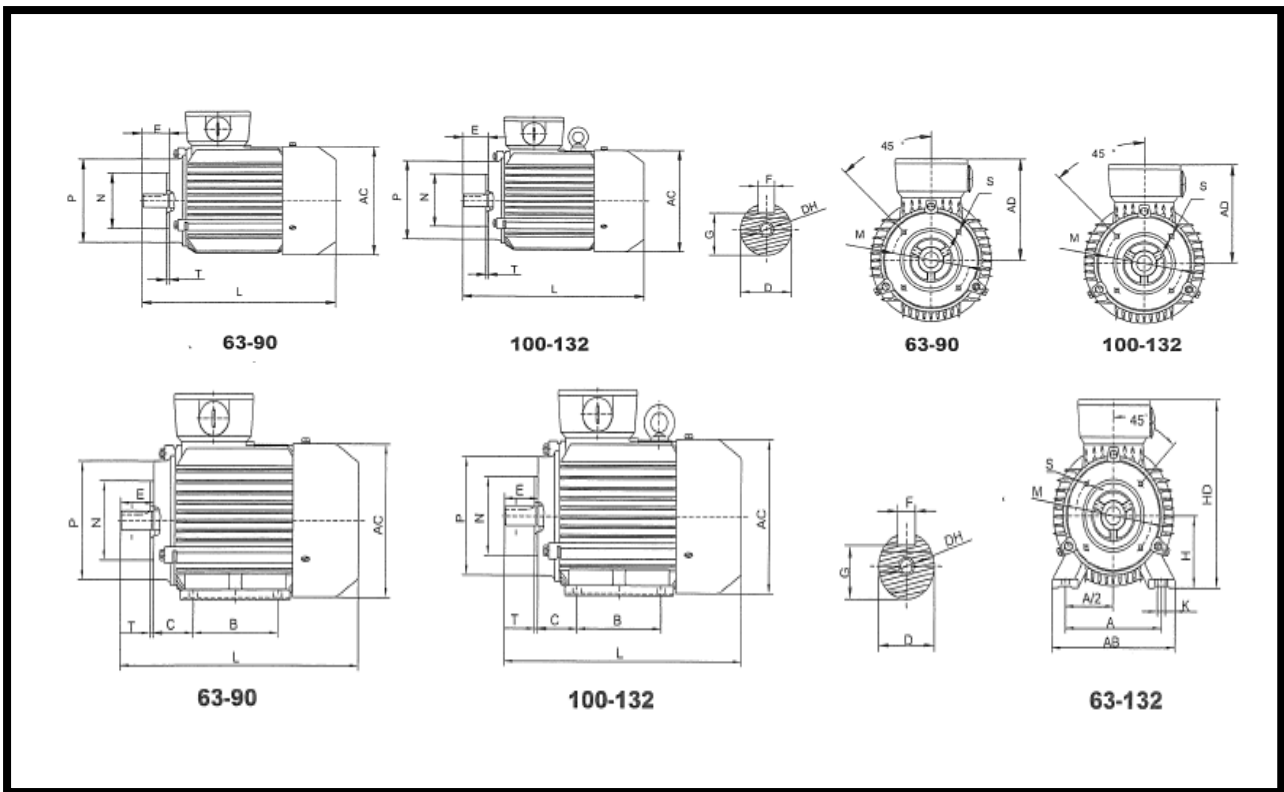

B14 – B34 grande / big / groot

Frame	A	A2	B	C	D	E	F	G	H	K	M	N	P	S	T	AB	AC	HD	DH	L
63	100	50	80	40	11	23	4	8.5	63	7	85	70	105	M5	2.5	135	120	180	M4X12	225
71	112	56	90	45	14	30	5	11	71	7	115	95	140	M6	2.5	150	136	195	M5X12	250
80	125	62.5	100	50	19	40	6	15.5	80	10	130	110	160	M6	3	165	156	214	M6X16	295
90S	140	70	100	56	24	50	8	20	90	10	130	110	160	M8	3	180	176	250	M8X19	315
90L	140	70	125	56	24	50	8	20	90	10	130	110	160	M8	3	180	176	250	M8X19	340
100L	160	80	140	63	28	60	8	24	100	10	165	130	200	M8	3.5	205	196	270	M10X22	385
112M	190	95	140	70	28	60	8	24	112	12	165	130	200	M8	3.5	230	220	300	M10X22	400
132S	216	108	140	89	38	80	10	33	132	12	215	180	250	M10	3.5	270	259	345	M12X28	470
132M	216	108	178	89	38	80	10	33	132	12	215	180	250	M10	3.5	270	259	345	M12X28	510
160M	254	127	210	108	42	110	12	37	160	15	265	230	300	M12	4	320	315	420	M16X36	615
160L	254	127	254	108	42	110	12	37	160	15	265	230	300	M12	4	320	315	420	M16X36	670